



■ Features :

- AC phase-cut dimming
- Work with leading edge and trailing edge TRIAC dimmers
- Built-in active PFC function
- Constant current design
- Protections: Short circuit / Over temperature
- Cooling by free air convection
- Fully isolated plastic case
- IP42 design
- Class II power unit, no FG
- Suitable for LED related fixture or appliance (such as LED Decoration or Advertisement devices)
- 100% full load burn-in test
- Low cost
- High reliability
- 3 years warranty



SPECIFICATION

MODEL		PCD-60-500B	PCD-60-700B	PCD-60-1050B	PCD-60-1400B	PCD-60-1750B	PCD-60-2000B	PCD-60-2400B
OUTPUT	RATED CURRENT	500mA	700mA	1050mA	1400mA	1750mA	2000mA	2400mA
	OPERATING VOLTAGE RANGE	70 ~ 108V	50 ~ 86V	34 ~ 57V	25 ~ 43V	20 ~ 34V	18 ~ 30V	15 ~ 25V
	CURRENT ACCURACY	±5.0%						
	RATED POWER	54W	60.2W	59.85W	60.2W	59.5W	60W	60W
	RIPPLE & NOISE (max.) Note.1	10.2Vp-p	5.6Vp-p	3.8Vp-p	3.4Vp-p	3.3Vp-p	2.4Vp-p	2.4Vp-p
	NO LOAD OUTPUT VOLTAGE (max.)	118V	100V	63V	50V	50V	35V	35V
SETUP TIME	500ms / 230VAC at full load							
INPUT	VOLTAGE RANGE	180~295VAC						
	FREQUENCY RANGE	47 ~ 63Hz						
	POWER FACTOR (Typ.)	PF>0.9/230VAC, PF>0.9/277VAC at full load (Please refer to "Power Factor Characteristic" curve)						
	TOTAL HARMONIC DISTORTION	THD< 20% when output loading≥60%(PCD-60-500B loading≥65%)at 230VAC input and output loading≥75% at 277VAC input						
	EFFICIENCY (Typ.)	87%	86%	86%	85%	85%	85%	84%
	AC CURRENT (Typ.)	0.6A/230VAC		0.5A/277VAC				
	INRUSH CURRENT(Typ.)	COLD START 13A (twidth=50μs measured at 50% Ipeak) at 230VAC						
	MAX. No. of PSUs on 16A CIRCUIT BREAKER	32 units (circuit breaker of type B) / 32 units (circuit breaker of type C) at 230VAC						
LEAKAGE CURRENT	<0.5mA / 240VAC							
PROTECTION	SHORT CIRCUIT	Hiccup mode, recovers automatically after fault condition is removed.						
	OVER TEMPERATURE	Shut down o/p voltage, auto-recovery						
ENVIRONMENT	WORKING TEMP.	-30 ~ +45°C (Refer to "Derating Curve")						
	WORKING HUMIDITY	20 ~ 95% RH non-condensing						
	STORAGE TEMP., HUMIDITY	-40 ~ +80°C, 10 ~ 95% RH						
	TEMP. COEFFICIENT	±0.03%/°C (0 ~ 50°C)						
	VIBRATION	10 ~ 500Hz, 2G 12min./1cycle, period for 72min. each along X, Y, Z axes						
SAFETY & EMC	SAFETY STANDARDS	ENEC EN61347-1, EN61347-2-13 independent, EN62384, EAC TP TC 004, IP42 approved						
	WITHSTAND VOLTAGE	I/P-O/P:3.75KVAC						
	ISOLATION RESISTANCE	I/P-O/P:100M Ohms / 500VDC / 25°C / 70% RH						
	EMC EMISSION	Compliance to EN55015, EN61000-3-2 Class C ; EN61000-3-3, EAC TP TC 020						
OTHERS	EMC IMMUNITY	Compliance to EN61000-4-2,3,4,5,6,8,11, EN61547, light industry level(Surge 2KV), criteria B, EAC TP TC 020						
	MTBF	358.030Khrs min. MIL-HDBK-217F (25°C)						
DIMENSION	DIMENSION	128*60*31.5mm (L*W*H)						
	PACKING	0.35Kg;30pcs/11.5Kg/0.58CUFT						
NOTE	1. Ripple & noise are measured at 20MHz of bandwidth by using a 12" twisted pair-wire terminated with a 0.1uf & 47uf parallel capacitor. 2. Direct connecting to LEDs is suggested, but is not suitable for using additional drivers. 3. To fulfill requirements of the latest ErP regulation for lighting fixtures, this LED power supply can only be used behind a switch without permanently connected to the mains.							

■ Mechanical Specification

Case No.:PCD40A Unit:mm

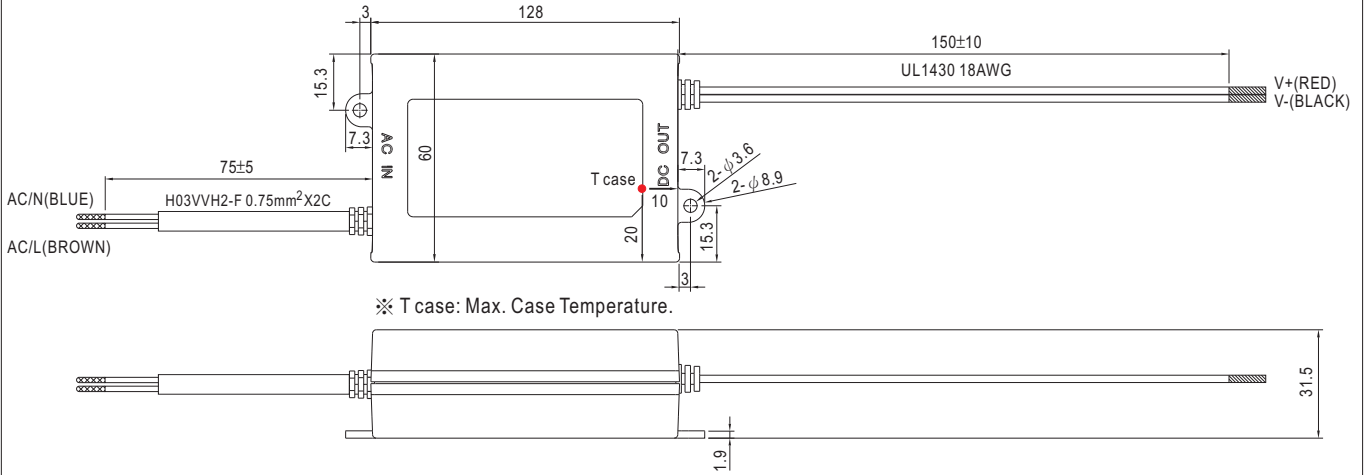

■ Block Diagram

fosc :60KHz(230VAC)

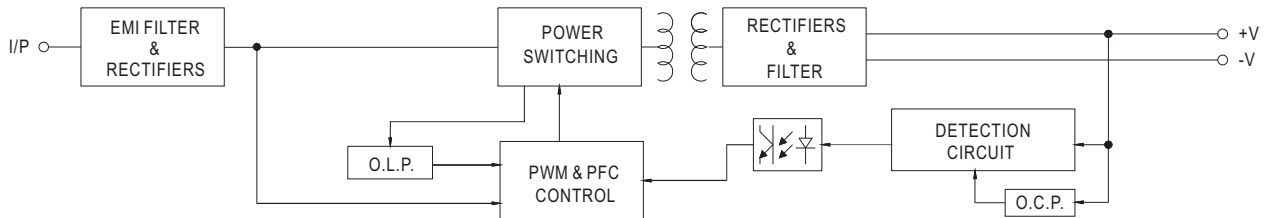

■ Derating Curve

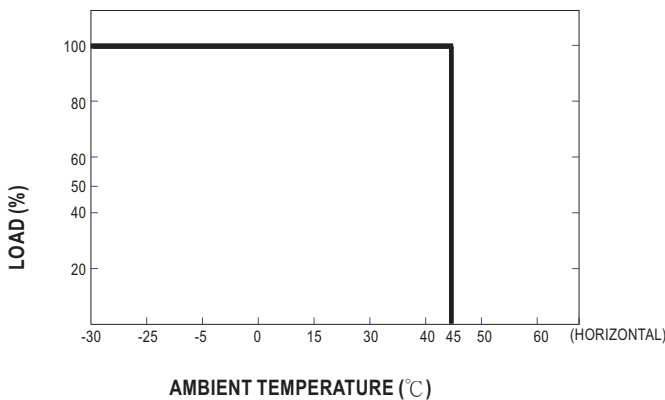

■ Static Characteristics

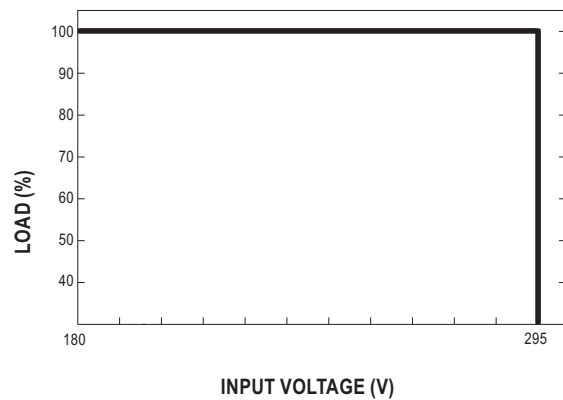

**Power Factor Characteristic**

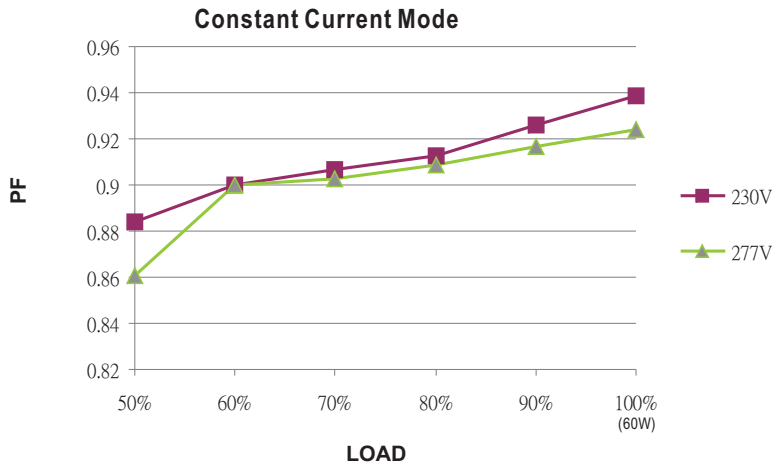

**EFFICIENCY vs LOAD (PCD-60-500B)**

PCD-60 series possess superior working efficiency that up to 87% can be reached in field applications.

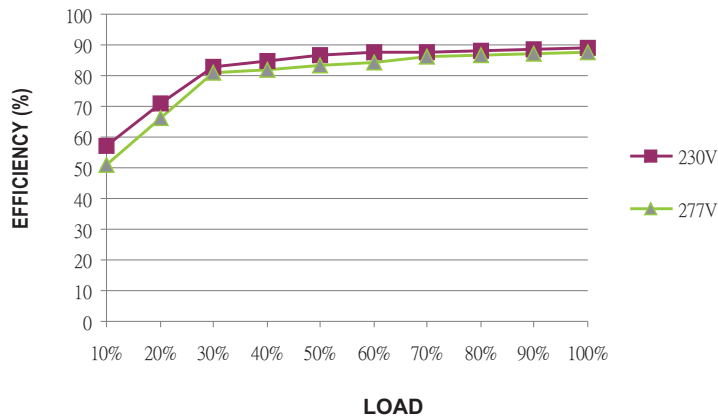

**AC Dimming Operation**

⊙ The following diagram depicts a typical installation utilizing the PCD-60 :

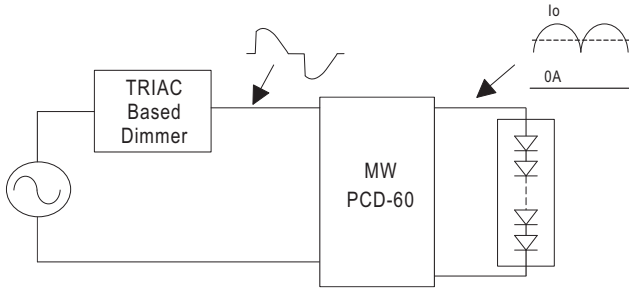

Under direct driving, the power supply will work in "constant current mode (CC)" and output voltage of the power supply will be clamped by sum of forward voltage (V<sub>F</sub>) of the LED strip.

⊙ Dimmer Compatibility Chart

Manufacturer	Dimmer Model	
LUTRON	SKYLARK SF-12P-277	(277VAC / 60Hz)
LUTRON	DVF-103P-277	(277VAC / 60Hz)
JUNG	Licht-Management 225 TDE	(230VAC / 50Hz)
JUNG	Licht-Management 225 NV DE	(230VAC / 50Hz)
BERKER	Tronic-Drehdimmer 286710	(230-240VAC / 50Hz)
CLIPSAL	32E450UDM	(220-240VAC / 50Hz)
CLIPSAL	NO 32E450TM	(220-240VAC / 50Hz)
CLIPSAL	NO 32E450LM	(220-240VAC / 50Hz)
CLIPSAL	Cat 400T	(230-240VAC / 50Hz)

Conduction angle: 30 degrees(min.) / 180 degrees(max.)